

Commercial Display Quick Start Guide

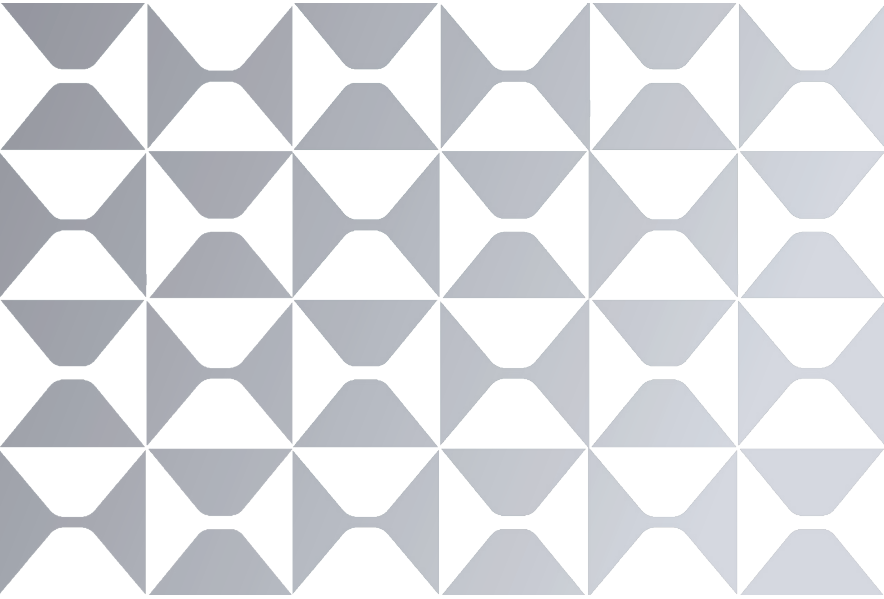

Model: ND43CMA / ND55CMA / ND65CMA
ND75CMA / ND86CMA / ND98CMA

MAXHUB

All the pictures in this manual are for reference only, subject to our available products.

Thank you for choosing MAXHUB product.

To ensure that you are able to fully utilize the capabilities of the product, we ask that you please read this user manual carefully and thoroughly before using the device. Should you have any questions or require assistance, please do not hesitate to contact our technical support team for guidance.

⚠ Safety Warnings

Placement

- (1) Please do NOT place the product on a slope, mount on an unstable stand or an insufficiently robust wall, a table nor a shelf.
- (2) Please do NOT expose the product to direct sunlight or any other heat source.
- (3) Please do NOT put the product near devices that generate strong magnetic fields.
- (4) Remove water splashes immediately with a clean dry cloth.
- (5) Please do NOT place any other heavy objects on the product.

Power Supply

- (1) Please check the product's operating voltage and frequency matches the local power configuration.
- (2) Please unplug the device during storming or thundering weather.
- (3) Please unplug the power should the product is left unused for long time.
- (4) Please keep the power cable from physical or mechanical damage.
- (5) Please use the original power cable from the accessory bag, don't modify or lengthen it.
- (6) Please make sure the AC is grounded.
- (7) This power cable comes with the device exclusively for this device only.

LCD Screen

- (1) Do NOT use hard nor sharp objects on the screen other than MAXHUB stylus.
- (2) Please unplug the power before cleaning the product.
Please clean the screen with a soft, dustless and dry cloth.
- (3) Please do NOT use water or liquid detergent to clean the product.
- (4) Please contact the authorised reseller for thorough cleaning.
- (5) Please do NOT display a high-brightness image on the screen for too long time.

Viewing Distance

For optimal viewing experience, it is recommended to position the commercial display at a distance that is 3-4 times the diagonal length of the screen.

Temperature & Humidity

- (1) Please do NOT put the product near a heater nor a radioactive source.
- (2) If the product is moved from a cold place to a warm one, please unplug the power cable and allow the product to gradually warm up for at least two hours to reduce the moisture.
- (3) Operating temperature of the product is 0°C-40°C, operating humidity is between 0%-90%RH.
- (4) avoid exposing the unit to rain or placing it in high humidity areas. Additionally, it is crucial to keep the unit in a dry and cool indoor environment.

Ventilation

Please ensure that the commercial display is placed in an area with adequate ventilation to allow for proper heat dissipation. It is recommended to leave a minimum of 10cm of space on the left, right, and back of the device, and 20cm of space above it to ensure proper airflow and optimal performance.

Earphone

When using the earphones, it is important to be aware that prolonged listening at high volumes may cause temporary or permanent hearing loss. To prevent this, we strongly recommend turning down the volume before inserting the earphones into your ears.

Energy Saving

Please note that pressing the power button briefly will not fully shut down the commercial display. Instead, it will enter standby mode, with only the screen turning off. To properly shut down the device, press and hold the power button for approximately 3 seconds and confirm the shut down command that appears on the center of the screen.

Notes for Cleaning

Please do not block or cover the heat vents on the back panel and do not spray liquids on the device.

Power Switch Status Signs

"I" means power on, "O" means power off.

Maintenance

Please contact authorised reseller for maintenance or repairing.

⚠ Warranty Exclusions

MAXHUB does not warranty Products that match any one or few of the following descriptions:

- (1) Product damage caused by violating the user manual.
- (2) Hardware damage caused by improper setup.
- (3) Product damage caused by unauthorised modification or maintenance.
- (4) Product damage caused by using in an unsuitable environment.
- (5) Product damage caused by abnormal external force.
- (6) Product damage caused by natural disasters or other force majeure.
- (7) Damaged Warranty Sticker.
- (8) Unable to provide effective purchase certificate.

I. Unboxing Checklist

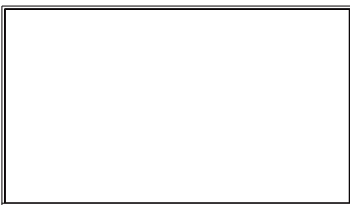

Commercial Display x1

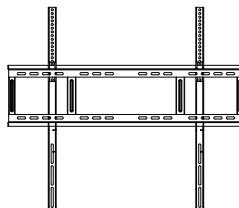

Wall Mounting x1

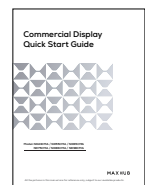

Quick Start Guide x1

MAXHUB



Remote Control×1

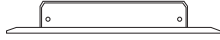

WiFi Module (SI07B) ×1



Power Cord*×1

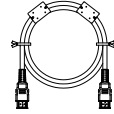

HDMI Cable (2M)×1

Note:  Power cord could be different for different regions , pls refer to the actual product.

II. Installation Guide

1. Confirm the panel installation position.

Align the wall-mounted screw holes with the studs on the back panel and fasten with 2 wall-mounted strips.

First, fasten the screws on the top side, then fasten the screws on the bottom side. A total of four screws are required.

Refer to the table below for the position of the lock hole.

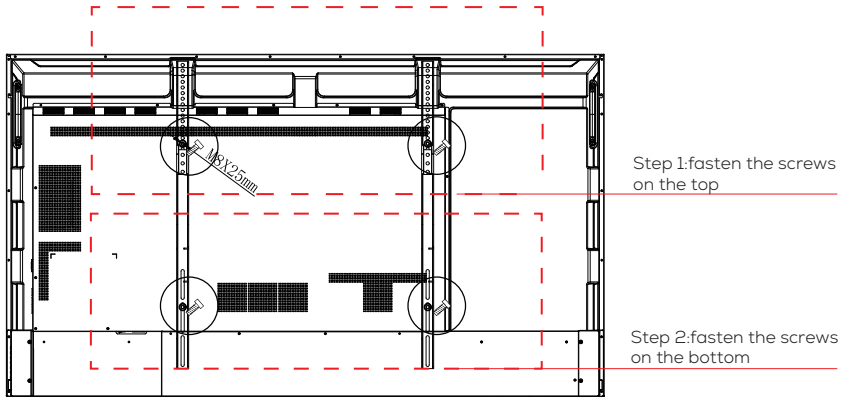

Series	Size	Bracket
ND** CMA	43",55"	WIB4722A
	65",75",86",98"	WIB9080A

2.Steps to install the wall mount

1 Take out the wall mount plate accessory package from the accessory box.

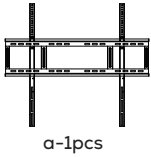

2 Take the panel out of the box and place it on a soft surface, such as a mat, to protect it during installation.

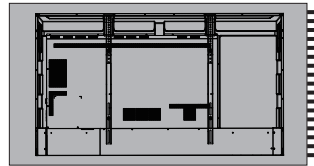
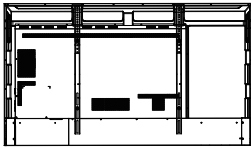

3 Take 8 pcs of expansion rubber plug b and screw it into the wall. It is recommended to use 10 mm impact drill bit.

4 Fix the wall bracket on 8 pcs expansion plug b with a combination of 8 pcs screw C and gasket d.

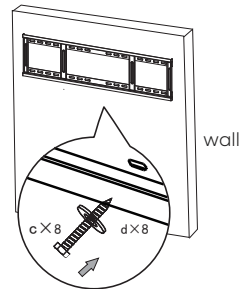
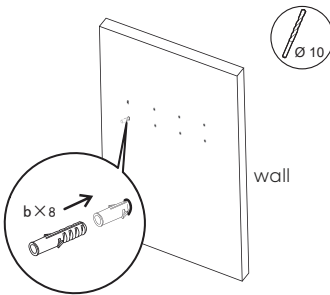

Note: At this moment please install the WiFi module if WiFi is required for this installation. (See III Installing the WiFi Module)

MAXHUB

⑤ Tighten the safety screw counter-clockwise to make the top of screw reach the second screw hole.

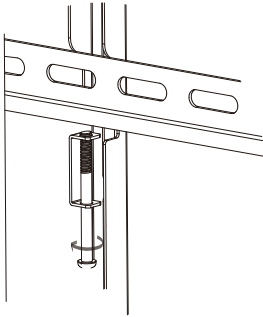

Note: This step is especially important for installation on the mobile stand. Tightening the safety screws will make device more stable.

⑥ Hang the panel vertically on the bracket and then finish installation.

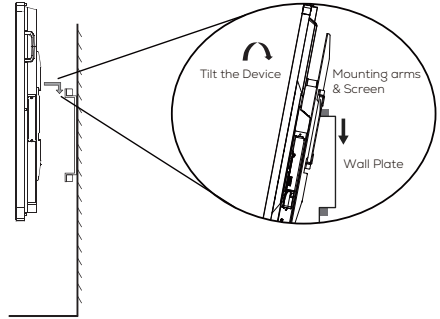

Note: Please keep the panel in the center of the bracket.

3.Reference On Wall Mount

When planning for wall mounting, it is important to take into consideration the physical dimensions of the panel. To ensure ease of use, it is recommended to maintain a proper distance between the wall and the back of the panel.

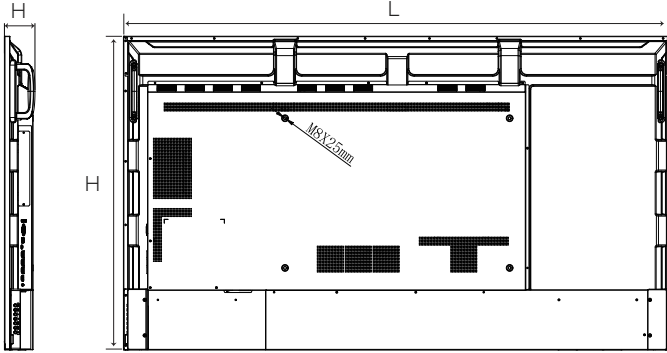

Series	Commercial Display					
Dimension	43"	55"	65"	75"	86"	98"
L	964.6 mm	1233 mm	1463.3 mm	1685.6 mm	1930.8 mm	2212.9 mm
H	552.5 mm	703.5 mm	838.3 mm	963.7 mm	1101.8 mm	1268.4 mm
W	71.4 mm	71.4 mm	76.4 mm	81.6 mm	81.6 mm	79.4 mm

NOTE: The table and diagram are only for reference.

III. Installing the WiFi Module

Please make sure that the following items are ready before setting up the wireless module.

- 1×Commercial Display
- 1×WiFi Module
- 2×Screws (CM3×6mm)

⚠ Please make sure the power cord of the Commercial Display is disconnected before installation.

Step1: Use a Phillips screwdriver to loosen two screws and remove the cover.

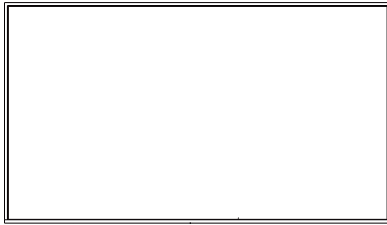

Step2: Insert the WiFi module into the wireless module slot and screw it up.

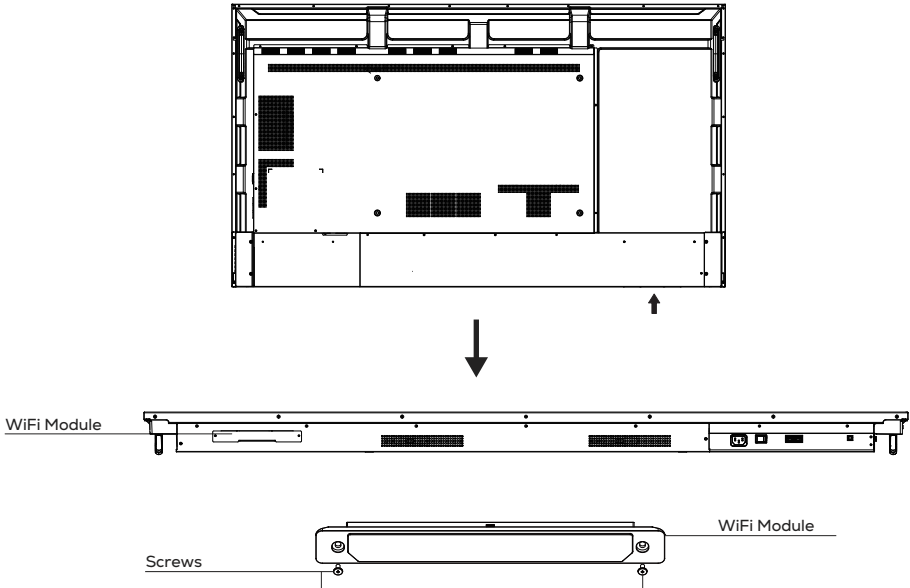

Note: This WiFi Module only works for the Commercial Display by plugging it into the above slot.

IV. Installing the PC module/Android Module

⚠ Please make sure the power cord of the Commercial Display is disconnected before installation.

Step1: Unscrew and remove the cover.

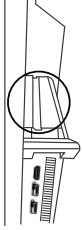

Step 2: Prepare the PC module/Android Module.

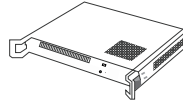

PC module

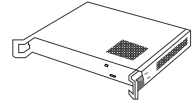

Android Module

Note: Android Module is only available in select market

Step3: Unscrew and remove the cover.

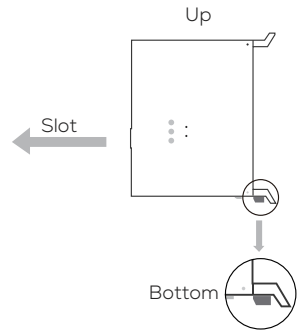
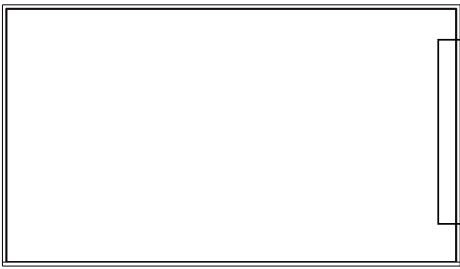

Step4: Installation of PC module/Android module..

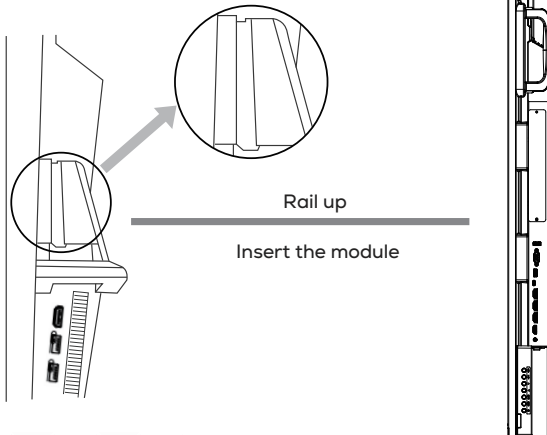

V. Removing the PC module/Android Module

⚠ Please make sure the power is off before proceeding with the removal.

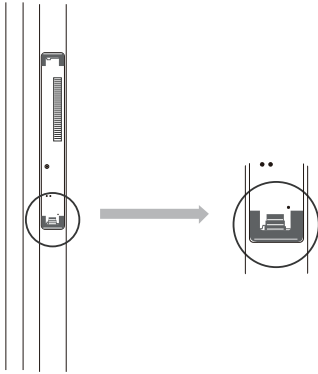

To remove the module, press up on the module and release the lock.

VI. Power On/Off

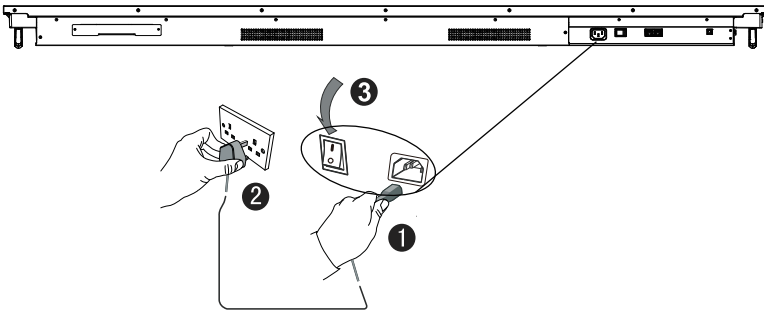

- 1 Plug the power cable into the power socket of the product.
- 2 Plug the power cable into the power supply.
- 3 Flip the rocker switch and press the power button. The indicator light will turn white when the product is powered on.

VII. Control Panel

(1) Please check connections are correct before starting.

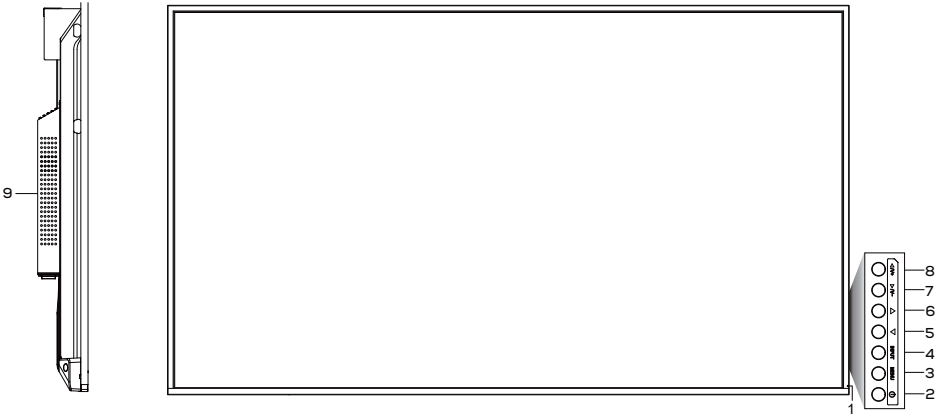

Number	Items
1	Power indicator light
2	⏻: Tap to enter energy-saving, press at least 2 seconds to enter standby mode
3	MENU: Pop up Settings menu
4	INPUT: Pop up channel Setting
5	◀: Press to scroll left
6	▶: Press to scroll right
7	⏮: Press to scroll down / Volume down
8	⏭: Press to scroll up / Volume up
9	Loudspeaker

Note: Different sizes of product horn position is not the same,subject to our available products

(2) Terminal Interface

Type 1:

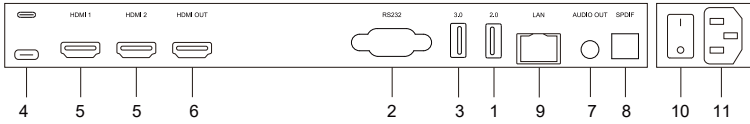

Type 2:

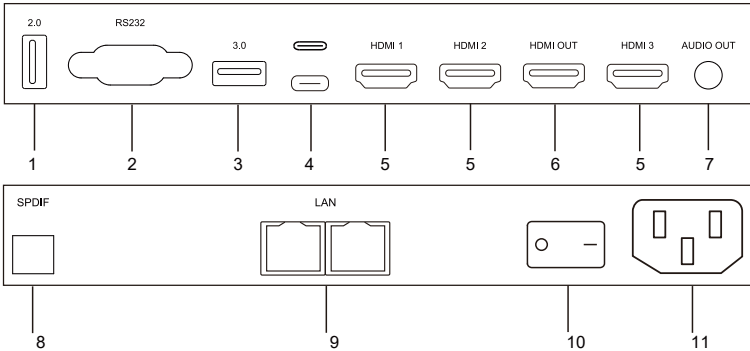

Number	Items	Function description
1	2.0	Connect USB devices such as mobile hard disk, U disk, USB keyboard and mouse, USB drives, etc.
2	RS232	Serial interface, used for mutual transfer of data between devices.
3	3.0	Connect USB devices such as mobile hard disk, U disk, USB keyboard and mouse, USB drives, etc.
4	USB Type-C	Support charging, data transmission, extension for audio and video output interface, etc. Note: The maximum rated power of the USB Type-C port of this product is 65W. When using this port to charge electronic devices, the charging power of the electronic device cannot exceed the rated power of this port. If the charging power of the electronic device exceeds the rated charging power of this port, please Do not directly use this port for charging.
5	HDMI	High-definition multimedia interface signal input, connect to devices with HDMI output interface (personal computer with HDMI output, set-top box, or another video device).
6	HDMI OUT	Connect to the devices with HDMI input function.
7	AUDIO OUT	Audio output to the external speaker.
8	SPDIF	Carry multichannel sound via optical signals.
9	LAN	Connect RJ45 terminals.
10	AU SWITCH	To open or shut down AC power supply. "I" means power on, "O" means power off.
11	AC IN	AC power input, connect AC power supply.

Note: Differences in the number and location of terminals of different sizes,subject to our available products.

Note:

- (1) 43~55 inch: USB Type-C、HDMI 1、HDMI 2 support HDMI OUT; Android channel: not support HDMI OUT.
- (2) 65~98 inch: PC channel、USB Type-C、HDMI 1、HDMI 2 Support HDMI OUT; Android channel、HDMI 3 not support HDMI OUT.

(3) Remote Control

• Remote Control Button Instruction

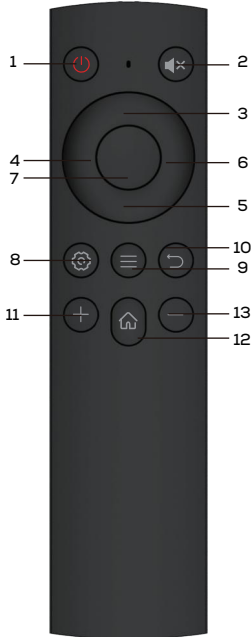

• Detailed Function Description

Number	Function description
1	Power on / off
2	Mute on / off
3	Up
4	Left
5	Down
6	Right
7	OK
8	Settings
9	Source menu
10	Back
11	Increase volume
12	Homepage
13	Decrease volume

• Remote Control Instruction

Install Batteries

- ① Open back cover of battery component on the back of remote control.
- ② Install AAA type battery according to the corresponding electrode, make sure battery positive and negative pole are correct ("+" to "+", "-" to "-"), please do not mix using old and new batteries.
- ③ After battery is installed, close the back cover of battery components, and make the following clip buckled to the bottom.

• Range of remote control

Remote control can work normally within the range of 8 meters distance, 30 degrees left and right from the remote-control receiver; in order to protect environment, please dispose waste battery into recycling box.

Note: The remote receiver is located at the behind of the panel.

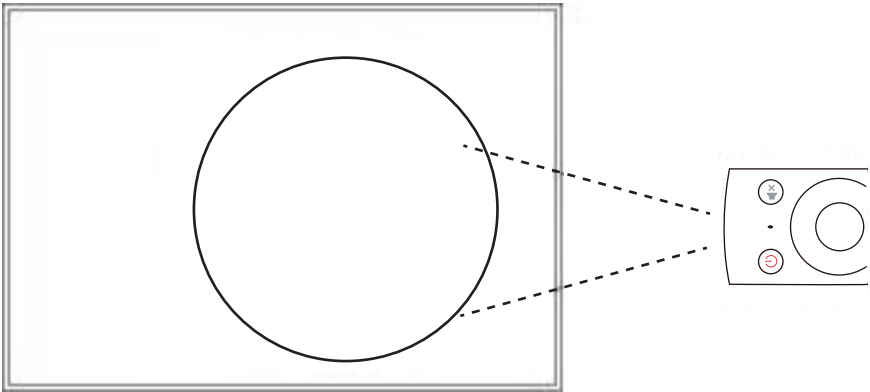

 If the battery is replaced by an incorrect type, it may lead to explosion.

IX.Wired Screen Share from your laptop to the display

Through USB Type-C

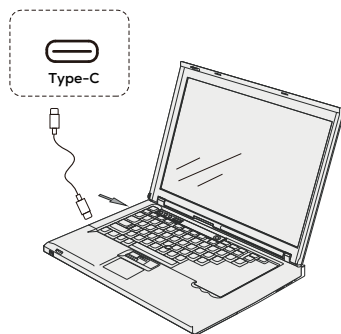
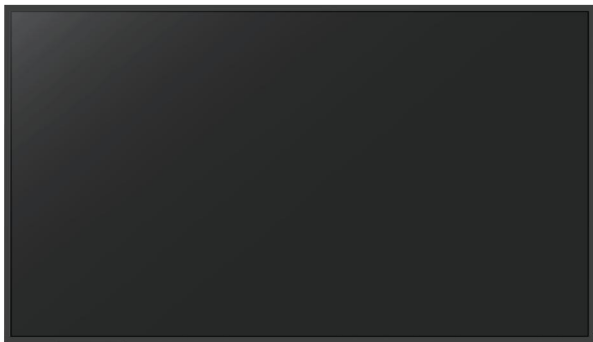

X.Frequently Connected Ports

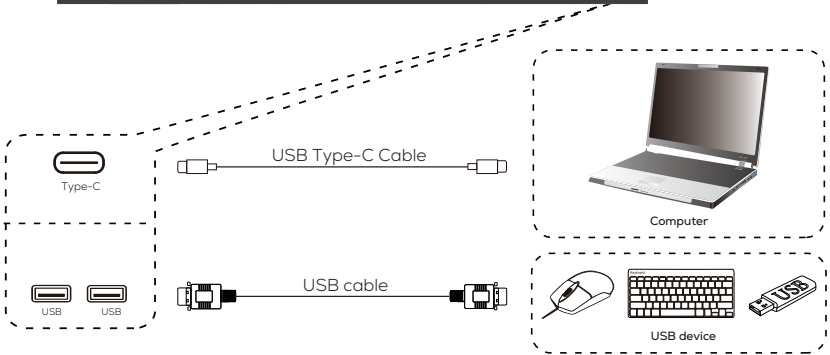
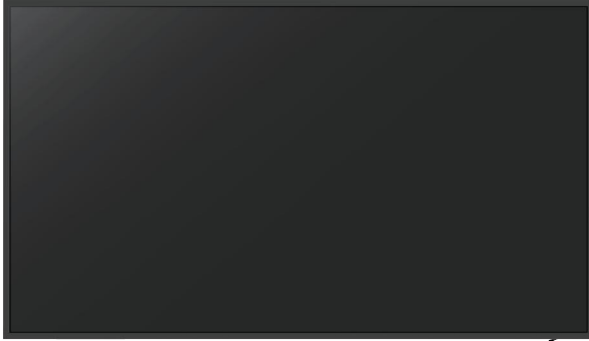

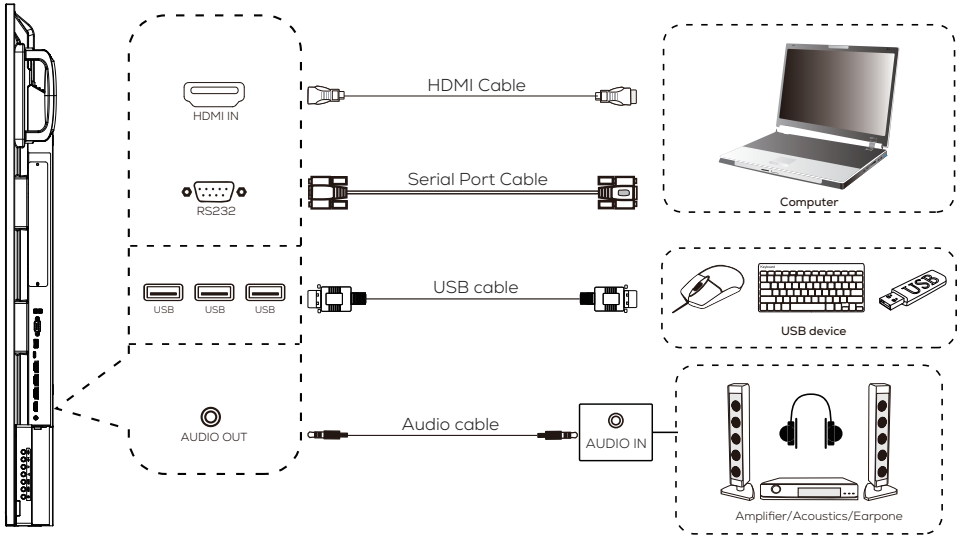

XI. First Start of MAXHUB Commercial Display

To start the MAXHUB ND**CMA, press the power key. Once the device is on, it is ready for use with all of its features.

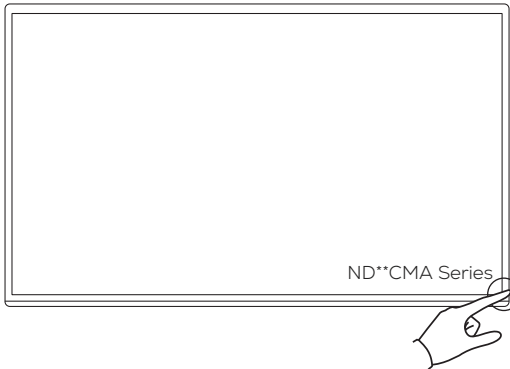

XII. Maintenance

To ensure the proper functioning of the product, it is important to keep it free of dust and moisture.

Regular cleaning with a soft, dust-free, and dry cloth is recommended. Remember to unplug the product before cleaning.

Cleaning the Screen

1. Please dissolve the fabric softener or detergent in 75% alcohol.
2. Please use a piece of soft cloth and soak it with the solution.
3. Take out the cloth and squeeze it dry before wiping on the screen.

Cleaning the Touch Frame

Please choose dry, soft and dust-free wipes to clean the touch frame.

Unplug Power

To protect the device during stormy weather or when it will not be in use for an extended period of time, it is recommended to unplug the power.

i. Energy Star Statement

ENERGY STAR is a U.S. Environmental Protection Agency voluntary program that helps businesses and individuals save money and protect our climate through superior energy efficiency. Products that earn the ENERGY STAR prevent greenhouse gas emissions by meeting strict energy efficiency criteria or requirements set by the U.S. Environmental Protection Agency. The following logo appears on all ENERGY STAR-certified models:

This product qualifies for ENERGY STAR in the “Standard mode” setting and this is the setting in which power savings will be achieved. Changing the Standard mode picture settings or enabling other features will increase power consumption that could exceed the limits necessary to qualify for ENERGY STAR rating. Refer to EnergyStar.gov for more information on Energy Star program.



MAXHUB

